

The Transistor Tester user manual

Power:

Transistor Tester can be powered from 6.8V – 12V DC. This can be achieved by a 9V layer-built battery. Two 3.7V Lithium-ion battery in series. Or AC adapter. When power on, the current is about 30mA at DC 9V.

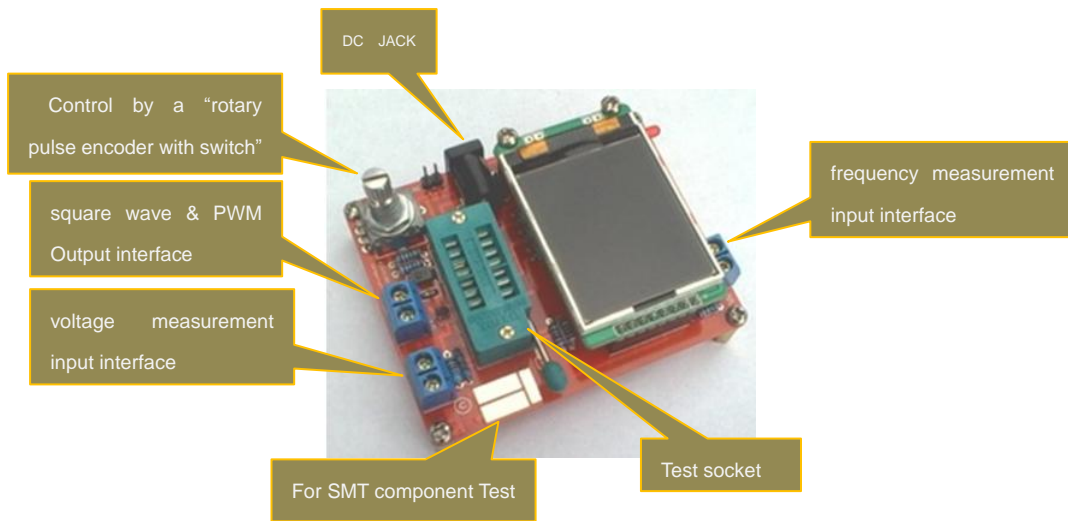

Control:

Transistor Tester is control by a "rotary pulse encoder with switch", or short by "RPEWS", this component have four mode of operation, a short time press the knob, press and hold, left and right rotate the knob.

when Transistor Tester is powered. a Short time press of the RPEWS will switch on the Transistor Tester, and start a Test. Transistor Tester will waiting for user input at the end of a test.

During a end of test, and before it's auto switch off. A long time press or Rotation of left and right the RPEWS will enter the function menu. In the function menu, a ">" at left column to index the Selected menu item. To enter the Specific function, just a click the RPEWS. Within the Specific function, press and hold the knob will exit and go back to the function menu.

Test:

Transistor Tester have three Test point(TP1,TP2,TP3), within the Test socket, the three is allocation as follow.

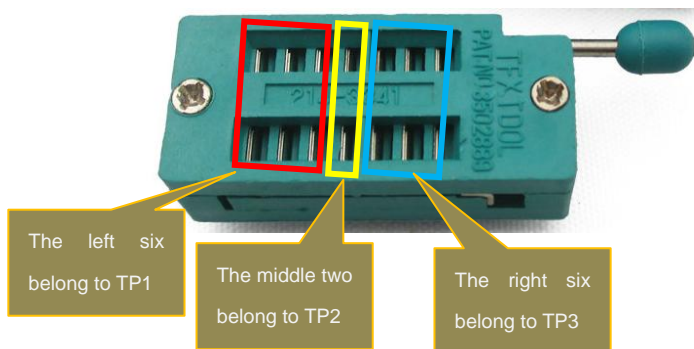

At right side of the Test socket is the SMT test pad, also have number to Identify each.

When test two lead component(resistor, capacitor, inductor), the two lead can select any two test point. if TP1 and TP3 is selected, the Test will enter to "series test mode" when the test is Completes. Else the test is start again by a shorttime press RPEWS.



Attention: All ways be sure to discharge capacitors before connecting them to the Tester! The Tester may be damaged before you have switched it on. There is only a little protection at the MCU's ports.

Extra caution is required if you try to test components mounted in a circuit. In either case the equipment should be

disconnected from power source and you should be sure, that no residual voltage remains in the equipment.

Self test and Calibration:

the self test can be prepared by connecting all three test point together and pushing of the RPEWS, the color of the Tester's LCD will change to white font and black background. Prompt string "Selftest mode. . ?", To begin the self test, the RPEWS must be pressed again within 2 seconds, else the tester will continue with a normal measurement.

Now self test is start, the tester will prompt you for next step. Wait for a time until Prompt string "isolate Probes!", at that time remove the connecting of the three test point. Tester will wait, until it's sense the disconnect. Then Tester continue the self test process. If this is the first time use self test(the Transistor Tester is assemble by yourself from scratch), Tester will soon Prompt string "1-|-3 > 100nf", A capacitor with any capacity between 100nF and 20μF connected to pin 1 and pin 3 is required for the last task of calibration, You should connect the capacitor, not before this text is shown. With this capacitor the offset voltage of the analog comparator will be compensated for better measurement of capacity values.

special using hints:

Normally the Tester shows the battery voltage with every start. If the voltage fall below a limit, a warning is shown behind the battery voltage. If you use a rechargeable 9V battery, you should replace the battery as soon as possible or you should recharge. the measured supply voltage will be shown in display row two for 1 second with "VCC=x.xxV". It cannot repeat often enough, that capacitors should be discharged before measuring. Otherwise the Tester can be damaged before the start button is pressed. If you try to measure components in assembled condition, the equipment should be all ways disconnected from power source. Furthermore you should be sure, that no residual voltage reside in the equipment. Every electronical equipment has capacitors inside!

If you try to measure little resistor values, you should keep the resistance of plug connectors and cables in mind. The quality and condition of plug connectors are important, also the resistance of cables used for measurement. The same is in force for the ESR measurement of capacitors. With poor connection cable a ESR value of 0.02Ω can grow to 0.61Ω.

You should not expect very good accuracy of measurement results, especially the ESR measurement and the results of inductance measurement are not very exact

Components with problems:

You should keep in mind by interpreting the measurement results, that the circuit of the Transistor Tester is designed for small signal semiconductors. In normal measurement condition the measurement current can only reach about 6 mA. Power semiconductors often make trouble by reason of residual current with the identification and the measurement of junction capacity value. The Tester often cannot deliver enough ignition current or holding current for power Thyristors or Triacs. So a Thyristor can be detected as NPN transistor or diode. Also it is possible, that a Thyristor or Triacs detected as unknown. Another problem is the identification of semiconductors with integrated resistors. So the base -emitter diode of a BU508D transistor cannot be detected by reason of the parallel connected internal 42Ω resistor. Therefore the transistor function cannot be tested also. Problem with detection is also given with power Darlington transistors. We can find often internal base - emitter resistors, which make it difficult to identify the component with the undersized measurement current.

Measurement of PNP and NPN transistors:

For normal measurement the three pins of the transistor will be connect in any order to the measurement inputs of the Transistor Tester. After pushing the RPEWS, the Tester shows in row1 the type (NPN or PNP), a possible integrated protecting diode of the Collector - Emitter path and the sequence of pins. The diode symbol is shown with correct polarity. Row 2 shows the current amplification factor ($h_{fe}=\dots$) and the Base - Emitter threshold voltage. You should know, that the Tester can measure the amplification factor with two different circuits, the common Emitter and the common Collector circuit (Emitter follower). Only the higher result is shown on the LCD.

With Germanium transistors often a Collector cutoff current I_{CEO} with current less base or a Collector residual current I_{CES} with base hold to the emitter level is measured.

Measurement of JFET and D-MOS transistors:

Because the structure of JFET type is symmetrical, the Source and Drain of this transistor cannot be differed. Normally

one of the parameter of this transistor is the current of the transistor with the Gate at the same level as Source. This current is often higher than the current, which can be reached with the measurement circuit of the Transistor Tester with the 680Ω resistor. For this reason the 680Ω resistor is connected to the Source. Thus the Gate get with the growing of current a negative bias voltage. The Tester reports the Source current of this circuit and additionally the bias voltage of the Gate. So various models can be differed. The D-MOS transistors (depletion type) are measured with the same method.

You should know for enhancement MOS transistors (P-E-MOS or N-E-MOS), that the measurement of the gate threshold voltage (V_{th}) is more difficult with little gate capacity values. You can get a better voltage value, if you connect a capacitor with a value of some nF parallel to the gate/source. The gate threshold voltage will be find out with a drain current of about 3.5mA for a P-E-MOS and about 4mA for a N-E-MOS

Function menu descriptions:

1. Switch off

Enter this Function the Tester will shut down immediately.

2. Transistor

Transistor test, it's also the default Function at switch on.

3. Frequency

Measurement of frequency, For frequencies below 25kHz the normal measurement is followed by a measurement of period time. This additional measurement is only followed after a normal frequency measurement.

4.f-Generator

Signal generation, this Function can output square wave .with various of frequency to choice.

5. 10-bit PWM

The function "10-bit PWM" (Pulse Width Modulation) generates a fixed frequency(7812.5Hz) with selectable pulse width at the pin TP2. With a short key press (< 0.5 s) the pulse width is increased by 1%, with a longer key press the pulse width is increased by 10%. If 99% is overstepped, 100% is subtracted from the result. The function can be exit with a very long key press (> 1.3 s).

6. C+ESR@TP1:3

The additional function "C+ESR@TP1:3" selects a stand-alone capacity measurement with ESR (Equivalent Series Resistance) measurement at the test pins TP1 and TP3. Capacities from 2μF up to 50mF can be measured. Because the measurement voltage is only about 300mV , in most cases the capacitor can be measured "in circuit" without previous disassembling. The series of measurements can be finished with a long press of RPEWS.

7.Selftest

With the menu function "Selftest" a full self test with calibration is done. With that call all the test functions T1 to T7 and also the calibration with external capacitor is done every time.

8. Voltage

Voltage measurement, Because a 10:1(180K:20K) voltage divides is connected , the maximum external voltage can be 50V, The measurement can also be exit by Continuous rotation of the RPEWS.

9. Show data

The function ,"Show Data" shows besides the version number of the software the data of the calibration. These are the zero resistance (R0) of the pin combination 1:3, 2:3 and 1:2 .In addition the resistance of the port outputs to the 5V side (RiHi) and to the 0V side (RiLo) are shown. The zero capacity values (C0) are also shown with all pin combinations (1:3, 2:3,1:2 and 3:1, 3:2 2:1). At last the correction values for the comparator (REF C) and for the reference voltage (REF R) are also shown. Every page is shown for 15 seconds, but you canselect the next page by a key press or a right turn of the rotary encoder. With a left turn of the rotary encoder you can repeat the output of the last page or return to the previous page.

10. FrontColor

This function can change the color of the font, the 16bit color is encode in RGB(565) format, that mean red maximum = 31, green maximum = 63,blue maximum = 31 respectively. In the function, a short time press can index the base color to change, turn left decrease it value and turn right increase it value. A long time press will save the Result and exit the function, please keep in mind the FrontColor and the backcolor cannot be the same. This will case the LCD show nothing. If this happens, you need to do a Selftest , how to enter the Selftest is descriptions at Page 2. Selftest will change the back

Color to black and font color to white automatically. When the Selftest is finish . you will have the chance to modify the color .

11. BackColor

This is function is the same as the FrontColor except it's change the background color .

12. 1-||-3

This function can series Measurement the capacitance at TP1 ,TP3, this function can Measurement very small capacitor. A long time press will exit the function.

13. 1-□-~3

This function can series Measurement the Resistance and inductance at TP1 ,TP3, A long time press will exit the function.

14.DS18B20

The DS18B20 is a Digital Thermometer with 1 Wire communicating protocol , it Looks like a Transistor due to the component package of TO-92, so it can fit into the Transistor tester.

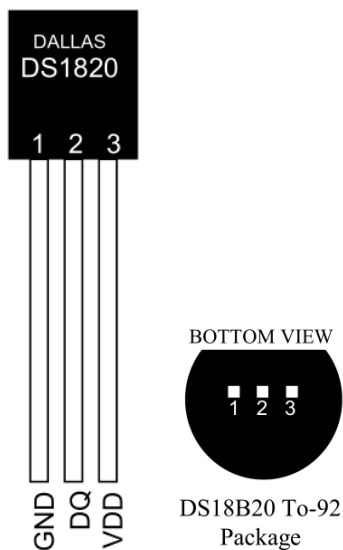

When enter to this function, the Row 2 of the LCD is show a string "1=GND 2=DQ 3=VDD" , it's mean TP1 of the tester connect the GND of the DS18B20 , and so on. The Tester can not sense the pin distribution of the DS18B20, because DS18B20 is a integrated circuit. Must according to the string to install the DS18B20.

The Tester read the temperature use 12bit resolution, it first start a "Convert T"[44h] command, and then series read the 9 byte of the "SCRATCHPAD" and the "64-BIT LASERED ROM". Fetch the first two byte within the "SCRATCHPAD", conversion this first two byte to readable temperature show at row 3 of the LCD .

Scratchpad	BYTE
TEMPERATURE LSB	0
TEMPERATURE MSB	1
TH/USER BYTE 1	2
TL/USER BYTE 2	3
CONF IG	4
RESERVED	5
RESERVED	6
RESERVED	7
CRC	8

For example:

Follow is a read of the DS18B20.

Scratchpad:

EC014B467FFF0C102A

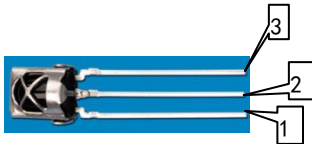

1= DOUT 2=GND 3=VCC

When enter to this function, the Row 2 of the LCD is show a string “1=DOUT 2=GND 3=VCC” , it’s mean TP1 of the tester connect the GND of the IR receiver module, and so on.

Look like this

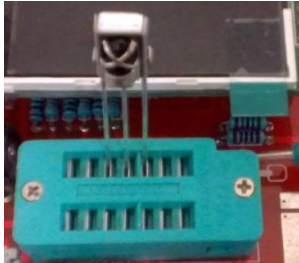

The function support two infrared remote control protocol

1. uPD6121

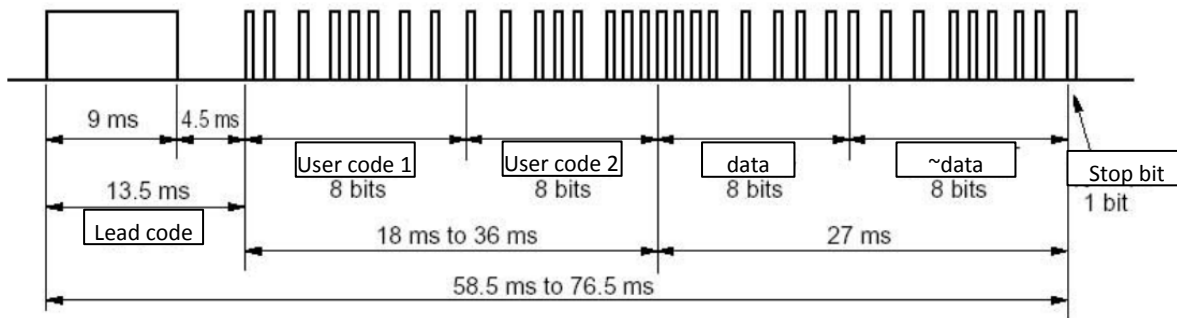

2.TC9012

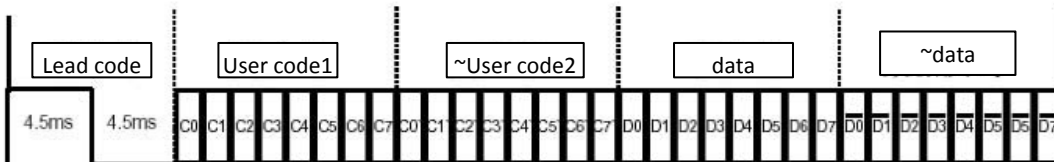

This two protocol are all same except the lead code, the protocol 1 is 9ms+4.5ms ,but the protocol 2 is 4.5ms+4.5ms

A success decode is list at row4 - 8 of the LCD, where row 4 display the IR protocol (TC9012 or uPD6121), row5 and row6 display “User code 1” and “User code 2” , row 7 display the data and the Bitwise NOT of the data(~data). Row8 is display the four byte together.

the hexadecimal system is used to display All of the numbers.

16.IR_Encoder

This function is a simulation of IR Remote Controller. it can drive a IR LED connect at the tester’s PWM output interface associate with the user input . since the tester only provide about 6mA current, the Control distance is less-than a regular IR Remote Controller.

On the first column of the LCD , is show a “>” , this symbol can move up or down by a click of the rotary encoder to select a certain item.

Row2 of the LCD is select protocol, like IR_Decoder above, there are two protocol for select, “TC9012” and “uPD6121”. It can be changed by rotate the knob, when the “>” appear at row2.

row3 and row4 change the “user code 1” and “user code 2” value by rotate the knob ,left rotate will decrease and right rotate will increase the value . press and hold the knob for >1S and <3S (>3S will exit this function) will add the value by 0x10 to fast reach to the expect value.

Row5 change the "data" ,and the Bitwise NOT of the "data" (~data) is auto calculate by the tester .

Row6 ,The "emit:" is used to start a transmit . move ">" to this line, and rotate the knob ,a "->" will appear soon untill a transmit complete.

This function is "strongly" correlation with the 16.IR_decoder . without decoder ,the value of the user code and data is unknown. Unless you already know them before. Used other methods.

The infrared remote control protocol of "TC9012" is frequent use on television in my submission. I think , in china.

17. C(uF)- correction

This function set the correction value for big capacitor measurement, Positive values will reduce measurement results.

At last:

For more information about the Transistortester, please visit

<http://www.mikrocontroller.net/articles/AVR-Transistortester>